



*Your Passport for Being Unique*

## BMW E28 Headlights Wiper Kit



## Installation Manual

 English

This document was created to guide you through the installation process. It remains your responsibility to ensure that no damage is sustained to your car, the purchased product, or self during this process

**Thank you for your purchase!**

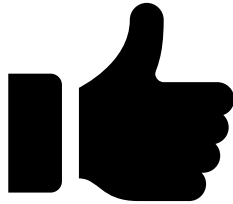

**We always recommend that you fasten  
your seatbelt while driving**

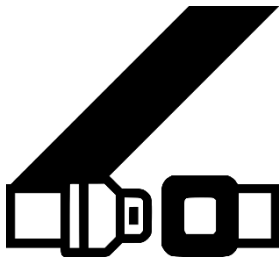

**#iDriveiCare**

## Table of contents

1. Product introduction
2. Contents of the headlight wiper kit
3. Recommended tools
4. Identifying your headlight grill trim specs
5. Guidance on how to remove your headlight grill trim
6. Identifying the fitting position for both the water spray nozzle and the headlight wiper fitting bolt
7. Removing the headlight retention ring
8. Installing and positioning of the wiper blades stoppers
9. Refitting the headlight grill trim
10. Installing the headlight wiper arms

## About this product

We are proud to introduce this BMW E28 headlight wiper custom kit in OEM quality. It was carefully re-manufactured to meet your standards and provide car enthusiasts with an affordable and durable accessory without having to worry about its fitment



# Inside your package, you will receive

- A. x4 Wiper blades with fitting ball joint
- B. x2 Headlight wiper arms (Left and Right)
- C. x12 Wiper blades guide with fitting bolts
- D. x2 Water nozzle spray
- E. x2 Wiper arms fitting kit (Used if the original headlight wiper motor is not available)

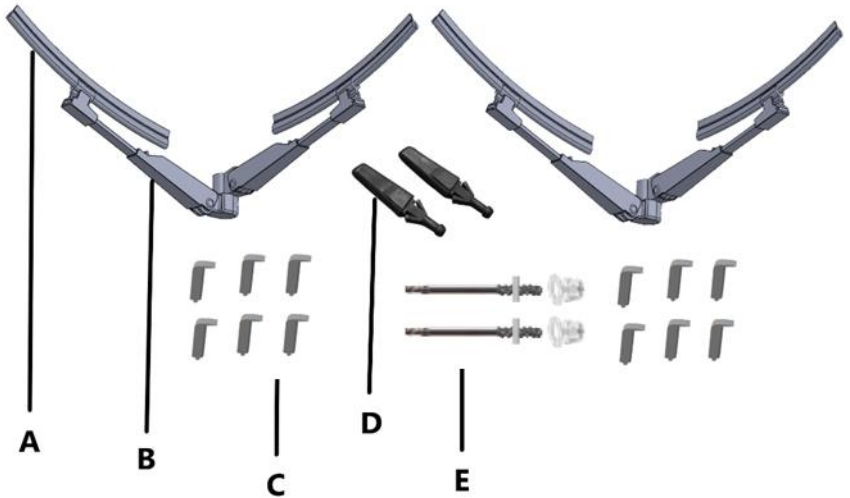

## Recommended tools:

- 1- 8mm Ratchet, spanner or socket tool



- 2- 3mm drilling bit to fit the headlight ring wiper blade guides

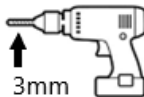

- 3- Headlight grill wiper arm and water spray nozzle drilling bit (For US specs headlight grill models only)

Wiper blade stopper drill



6mm

Water nozzle spray square drill



9.5mm

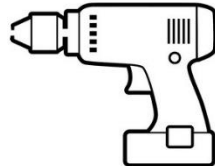

Note: The above tools are not included with your wiper kit and modifying your grill is at your own risk

## Before you start

First, you need to establish whether you have the Euro or US specs headlight grill trim. Below you will see an example of both grills

**Photo 1 (BMW E28 Headlight Grill Specs Differences)**



**US Specs**

(Without Wiper and water spray hole)

**Euro Specs**

(With wiper and water spray nozzle hole)

A: Headlight wiper motor hole

B: Water nozzle spray hole

**Note:** The US grill specs do not have a pre-drilled hole to fit the headlight motor shaft or the water spray nozzle. In this case, you will need to drill at your own risk

# Installation Guide

Remove both headlight grills (left and right) by unclipping the upper metal fasteners and unscrewing the lower bolts

**Photo 2** (BMW E28 Headlight grill fitting details)

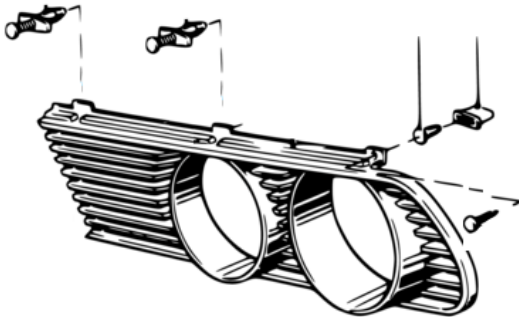

**Note:** If you already have both headlight wiper motors installed, you can directly bolt your wipers to the motor shaft without installing the fitting bolt. The wiper arms are designed to fit OEM to the original motor shaft



# Installation Guide

1. Install the wiper fitting bolt in position A (See Below)
2. Install the water nozzle spray in position B from the outside by pushing it in till you hear a click  
(Optional if you do not have the washing system installed)

**Photo 3 (Water nozzle spray & wiper arm fitting kit location)**

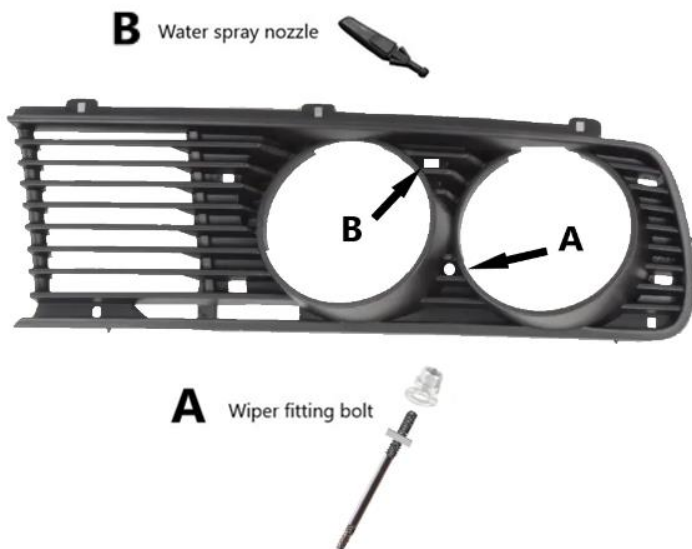

# Installation Guide

3. Remove all 4-headlight glass retention ring by gently pulling them out

**Photo 4 (BMW E28 headlight retention ring)**



Retention Ring Lock

Note: The headlight retention rings have a lock-in clip. You need to consider this when removing, drilling, and reinstalling it back to the headlight for correct fitment

## Installation Guide

4. Drill (8x) 3mm holes for the smaller retention ring and (4x) 3mm holes for the large retention ring and fit the wiper blade guiding tab. (Only drill retention rings with no pre-existing wiper blade guides)

**Photo 5 (The correct position of the wiper blade guiding tabs in the photo below)**



# Installation Guide

5. Reinstall the headlight grills back to the car  
(Check photo 2 above for reference)
6. Install the headlight wiper arms over the fitting kit and tighten the bolt to hold the wiper in place  
(Check left and right wiper arm fitment)

**Photo 6 (Wiper arms installation)**

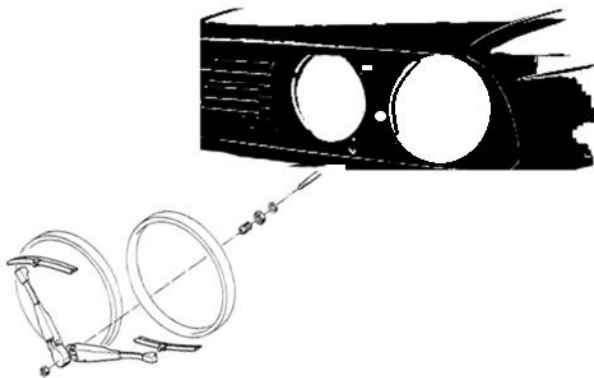

**Note:** Make sure that you calibrate the wiper arms rotation position before lowering the wiper blades when installing to an operational wiper motor to avoid miscalibration damage



Congratulation for installing the  
BMW E28 Headlight wipers in your car

You are now officially **Unique**

[www.MYclassicparts.com](http://www.MYclassicparts.com)